

# Rules for International Wushu Sanshou Competition

## CONTENTS

### Chapter 1 General Rules

- Article 1 Types of Competition
- Article 2 Systems of Competition
- Article 3 Qualifications and Requirements
- Article 4 Weight Categories
- Article 5 Weighing-in
- Article 6 Drawing Lots
- Article 7 Dress and Protective Gear
- Article 8 Competition Protocol
- Article 9 Default
  
- Article 10 Other Provisions in Competition

### Chapter 2 Officials and Duties

- Article 11 Officials
- Article 12 Support Staff
- Article 13 Duties of Contest Officials

### Chapter 3 Jury of Appeal and Its Duties

- Article 14 Composition of the Jury of Appeal
- Article 15 Duties of the Jury of Appeal
- Article 16 Procedure and Requirements of Appeal

### Chapter 4 Competition Methods, Scoring Criteria and Penalties

Article 17 Competition Methods

Article 18 Prohibited Areas

Article 19 Scoring Areas

Article 20 Prohibited Methods

Article 21 Scoring Criteria

Article 22 Fouls and Penalties

Article 23 Stopping the Contest

## **Chapter 5 Winning and Placing**

Article 24 Winner and Loser

Article 25 Placing

## **Chapter 6 Arrangement of Competition and Recording**

Article 26 Arrangement of Competition

Article 27 Recording

## **Chapter 7 Calls and Gestures**

Article 28 Platform Judge's Calls and Gestures

Article 29 Sideline Judges' Gestures

## **Chapter 8 Competition Area and Equipment**

Article 30 Competition Area

Article 31 Equipment

# CHAPTER 1

## GENERAL RULES

### Article 1 Types of Competition

Sanshou competition is divided into team event and individual event.

### Article 2 Systems of Competition

2.1 Sanshou competition shall be conducted under the round-robin or elimination system.

2.2 Each bout consists of three two-minute rounds with a one-minute rest in between. A bout is won by the best two of three rounds.

### Article 3 Qualifications

3.1 The competitor must hold a passport issued by the country/region which he represents.

3.2 A senior competitor shall be 18-35 full years and a junior competitor shall be 15-18 full years of age at the time of competition.

3.3 The competitor must produce a personal insurance certificate.

3.4 The competitor must produce a health certificate showing his electroencephalogram (EEG), electrocardiogram (ECG), blood pressure and heart rate in a medical check-up taken within 20 days before his registration.

### Article 4 Weight Categories

- 4.1 48kg Category (Under  $\leq 48\text{kg}$ )
- 4.2 52kg Category ( $> 48\text{kg} - \leq 52\text{kg}$ )
- 4.3 56kg Category ( $> 52\text{kg} - \leq 56\text{kg}$ )
- 4.4 60kg Category ( $> 56\text{kg} - \leq 60\text{kg}$ )
- 4.5 65kg Category ( $> 60\text{kg} - \leq 65\text{kg}$ )
- 4.6 70kg Category ( $> 65\text{kg} - \leq 70\text{kg}$ )
- 4.7 75kg Category ( $> 70\text{kg} - \leq 75\text{kg}$ )
- 4.8 80kg Category ( $> 75\text{kg} - \leq 80\text{kg}$ )

4.9 85kg Category (>80kg—≤85kg)

4.10 90kg Category (>85kg—≤90kg)

4.11 Over 90kg **Category** (>90kg)

## **Article 5 Weighing-in**

5.1 The weighing-in shall be conducted by the chief registrar in collaboration with the scheduler-recorders under the supervision of the Jury of Appeal.

5.2 Only competitors with credentials shall be weighed in. They must show their passports at the time of weighing-in.

5.3 Competitors shall be weighed in at the designated place and at the designated time, either in the nude or only with their trunks on. (Female competitors may wear close-fitting undergarments.)

5.4 The weighing-in shall start with the lighter weight categories, each to finish in an hour. A competitor who outweighs his entered category and fails to reduce his weight within the stipulated time shall not be allowed to compete in any of the subsequent contests.

## **Article 6 Drawing Lots**

6.1 The drawing-lots ceremony shall be conducted by the scheduling-recording group, in the presence of the chairman of Jury of Appeal, the chief referee and team coaches or team leaders.

6.2 The drawing-lots ceremony shall take place after the first weighing-in, starting with the lighter weight categories. Any category with only one competitor shall be excluded from the contest.

6.3 The team coaches or team leaders shall draw lots for the competitors of their respective teams.

## **Article 7 Dress and Protective Gear**

7.1 Competitors shall wear boxing gloves, headgear and chest protectors designated by the Competition and use their own gum shields and cup protectors (under their trunks). Competitors' wear and protective gear shall be either red or black.

7.2 Competitors shall wear shirts and trunks in the same color as their protective gear. Female competitors may wear close-fitting undergarments.

7.3 The weight of gloves shall be 230 grams for 65kg category and under (and also for women and juniors of all categories), and 280 grams for the 70 kg category and above.

## **Article 8 Competition Protocol**

8.1 Competitors shall give a fist-palm salute when they are introduced to the audience.

8.2 Each round shall start with a fist-palm salute on the platform from both sides to their respective coaches, who shall answer with the same salute.

8.3 Each bout shall start with an exchange of fist-palm salute between the two sides.

8.4 At the announcement of the result, the two competitors shall exchange their positions. After the announcement, they shall give a fist-palm salute to each other and then simultaneously to the platform judge, who shall answer with the same salute, and then to the opponent's coach, who shall answer with the same salute.

8.5 Sideline judges shall exchange fist-palm salute at the time of replacement.

## **Article 9 Default**

9.1 A competitor who is unable to compete due to injury or illness, which must be proved by a platform doctor's prescription, or who is not qualified for competition due to over weight, shall be considered as a default, and shall not be allowed to take part in the subsequent contests. However, his results achieved in previous placings shall count.

9.2 If a competitor is being outclassed, his coach may, for the sake of safety, show the default plate. The competitor may also raise his hand to request a default.

9.3 A competitor who is absent for weighing-in, or who fails to answer the three roll-calls prior to a bout, or who leaves after the roll-calls without permission and fails to appear in time in the competition area, shall be regarded as a groundless default .

9.4 A competitor who makes a groundless default shall have all his results cancelled.

## **Article 10 Other Provisions During Competition**

10.1 All officials on duty shall concentrate on their work, without talking among themselves. Nor shall they leave their seats without the referee's permission.

10.2 All participating teams shall abide by the Rules and respect and obey the judges' decisions. It is prohibited to wrangle, curse, throw protective gear, or act in any way to vent discontent. Competitors are not allowed to walk out (except in cases of first-aid emergency) before the announcement of result of the bout.

10.3 The team coach and doctor may be seated at the designated place and are allowed to give massage or guidance to their athletes during the rest periods between the rounds.

10.4 Doping is strictly prohibited. Infusion of oxygen is forbidden during the rest periods between the rounds.

## CHAPTER 2

### OFFICIALS AND THEIR DUTIES

#### **Article 11 Officials**

11.1 There shall be one (1) chief referee and one (1) or two (2) assistant chief referees.

11.2 The jury on duty shall consist of one (1) head judge, one (1) assistant head judge, one (1) platform judge, one (1) recorder, one (1) timekeeper and three (3) or five (5) sideline judges.

11.3 One (1) chief scheduler-recorder

11.4 One (1) chief registrar

#### **Article 12 Auxiliaries**

12.1 Four (4) scheduler-recorders

12.2 Three (3) to five (5) registrars

12.3 Two (2) to three (3) medical workers

12.4 One (1) to two (2) announcers

### Article 13 Officials' Duties

13.1 The chief referee shall:

13.1.1 Organize all officials to study the Rules and Regulations of the Competition, and to master the officiating methods.

13.1.2 Make sure that everything is ready for competition in regard to the platform, equipment and officiating apparatus, and to the weighing-in, drawing of lots and programing.

13.1.3 Settle problems according to the Rules and Regulations, but without the power to modify them.

13.1.4 Provide guidance to juries in competition and replace officials if necessary.

13.1.5 Notify the referee, chief programr-recorder and announcers in time if any change has occurred in the order of competition owing to a competitor's default.

13.1.6 Have the right to make the final decision when a dispute arises in a jury.

13.1.7 See to it that the officials are implementing the Rules properly.

13.1.8 Examine, sign and announce the results of competition.

13.1.9 Submit a written summary report to the Organizing Committee.

13.2 The assistant chief referee shall assist the chief referee and may act on his behalf in his absence.

13.3 The head judge shall:

13.3.1 Organize his jury in its work and study.

13.3.2 Supervise and guide the work of the judges, timekeeper and recorder.

13.3.3 Whistle as a hint for correction, before the final result is announced, when the platform judge has made an apparent misjudgment or omission.

13.3.5 Announce the result at the end of each round to decide the winner.

13.3.6 Handle such matters as absolute victory, fall-off, penalty and forcible counting according to the competitors' conditions on the platform and the recorder's records.

13.3.7 Examine and sign the results at the end of each bout.

13.4 The assistant head judge shall assist the referee, and perform other officials' tasks concurrently when necessary.

13.5 The platform judge shall:

13.5.1 Check the competitors' protective gear and ensure safety in fighting.

13.5.2 Guide the fights through calls and gestures.

13.5.3 Make decisions on such matters as fall-down, fall-off, penalty, forcible counting and call for first aid.

13.5.4 Announce the result of a bout.

13.6 The sideline judges shall:

13.6.1 Award points to the competitors according to the Rules.

13.6.2 Display the results simultaneously and instantly at the head judge's signals at the end of each round.

13.6.3 Sign the scorecard at the end of each bout, to be kept for examination and verification.

13.7 The recorder shall:

13.7.1 Fill in the two fighters' forms carefully before the competition.

13.7.2 Participate in the work of weighing-in ceremony and record the competitors' weights in the statistical chart of the bout.

13.7.3 Record the numbers of warnings, admonitions, forcible counts and falls-off according to the platform judge's calls and gestures.

13.7.4 Decide the winner of each round according to the sideline judges' decisions and report to the head judge.

13.8 The timekeeper shall:

13.8.1 Check the gong and timing devices before the competition, making sure that the stop-watches keep correct time.

13.8.2 Keep a record of the time elapsed during the fights, stops and rest periods between the bouts

13.8.3 When the computer scoring system is not available, blow a whistle ten (10) seconds before the start of each round and beat a gong to announce its end.



13.8.4 Read out the **the** sideline judges' decisions.

13.9 The chief scheduler-recorder shall:

13.9.1 **Be** responsible for examining the competitors' **credentials** and entry forms.

13.9.2 **Organize** the drawing-lots ceremony and work out the competition schedule.

13.9.3 **Prepare** various forms to be used in competitions; check and verify the **competitors'** results **to determine** their placings.

13.9.4 **Record** and announce the results of **all** bouts.

13.9.5 **Collect** data **for statistics and completion of Results**.

13.10 The scheduler-recorders shall **perform tasks as** assigned by the chief scheduler-recorder.

13.11 The **chief** registrar shall:

13.11.1 **Be** responsible for the **competitors'** weighing-in ceremony.

13.11.2 **Be** responsible for **the preparation of** protective gear **and its management** during the **Competition**.

13.11.3 **Summon** the competitors for roll-calls twenty (20) minutes before the start of a contest.

13.11.4 **Report** to the chief referee **immediately in cases of** absence or default during the roll-calls.

13.11.5 **Check** the **competitors' dress** and protective gear as required by the Rules.

13.12 The registrars shall **perform tasks** as assigned by the chief registrar.

13.13 The announcers shall:

13.13.1 **Give** the audience **a general idea of** the Rules and Regulations of the **Competition**.

13.13.2 **Introduce** the judges and competitors **to the audience**.

13.13.3 **Announce** the results of competitions.

13.14 The medical **workers** shall:

13.14.1 **Check** the competitors' **health certificates**.

13.14.2 **Carry out** anti-doping tests **in cooperation** with the experts.

13.14.3 Conduct **selective** checkups **among** the competitors before the competition.

13.14.4 Provide first-aid **service** to injured or sick competitors during the Competition.

13.14.5 **Examine cases of** injury caused by fouls.

13.14.6 Be responsible for medical **supervision and propose** to the chief referee **in time to suspend injured or sick competitors from** competition.

## CHAPTER 3

### JURY OF APPEAL AND **ITS** DUTIES

#### **Article 14 Composition of the Jury of Appeal**

The Jury of Appeal **shall** be composed of one (1) chairman, one (1) vice chairman and three (3) or five (5) members.

#### **Article 15 Duties of the Jury of Appeal**

15.1 The Jury of Appeal **shall work** under the leadership of the **Organizing Committee of the Competition, being held** responsible mainly for supervising **international** competition, **on such matters as** checking the competition area and **facilities, equipment, scheduling, drawing of lots, competitors' weighing-in, grouping of officials and arrangement of their work.**

The Jury of Appeal shall supervise the officiating work. **In case of any obvious unjust behavior or incorrect judgment, it shall have the** right to give warnings to **the officials concerned and, in serious cases, may even propose** to the **IWUF** Technical Committee to **remove them from their current officiating work** to ensure the **smooth running of competitions.**

15.2 The Jury of Appeal shall deal with appeals submitted by participating teams **in** disagreement with the judges' decisions **concerning the Rules and Regulations of the Competition. But such** appeals shall be **confined to decisions** related to the appealing team.

15.3 The Jury of Appeal shall **handle the appeals** immediately **after receiving them and duly notify the parties concerned of the ruling.**

15.4 **The Jury of Appeal shall investigate the matter at issue and may watch the videotapes if necessary. It may hold discussion meetings and invite personages concerned to attend them as observers without the right to vote.**

The meetings must be attended by more than half of the members of the Jury of Appeal. Only decisions made by more than half of its members present at the meeting shall come into effect. In case of a tied vote, the chairman shall have the right to make the final decision.

15.5 Members of the Jury of Appeal shall withdraw from discussions and voting on issues in which their country or region is involved.

15.6 After strict and careful reexaminations of the problem raised in the appeal, the original decision shall remain unchanged if it is confirmed to be right. If it is confirmed to be obviously wrong, the Jury of Appeal shall request the IWUF Technical Committee to deal with the officials who have made the misjudgment. However, the result shall remain unchanged. The decision of the Jury of Appeal shall be final.

## **Article 16 Procedure and Requirements of Appeals**

16.1 A participating team in disagreement with the judges' decisions shall submit its appeal in written form through its representative or coach to the Jury of Appeal within 15 minutes after the conclusion of the contest, together with a fee of US\$100. The fee will be returned if the appeal proves to be justified. If not, the original decision will remain unchanged and the fee will not be returned.

16.2 All teams shall abide by the final decisions made by the Jury of Appeal. Strict measures will be taken, according to the severity of the case and IWUF's relevant rules, against trouble-making caused by disobedience to the decisions.

## **CHAPTER 4**

### **FIGHTING METHODS, SCORING CRITERIA AND PENALTIES**

#### **Article 17 Fighting Methods**

All attacking and defending techniques of sanshou may be used in fighting .

#### **Article 18 - Prohibited Methods**

20.1 Attacking with the head, the elbow, or the knee, or by twisting the opponent's joints.

20.2 Forcing the opponent to fall head over heels, or intentionally smashing or pressing him down.

20.3 Hitting the opponent's head by any means when he is already down.

## Article 19 Prohibited Areas

The back of head, the neck and the crotch.

## Article 20 Scoring Areas

The head, the trunk and the thighs.

## Article 21 - Scoring Criteria

21.1 A competitor will be awarded two (2) points

21.1.1 When the opponent falls off the platform;

21.1.2 When he remains standing while the opponent falls down ;

21.1.3 When he hits the opponent's head or trunk with the leg technique;

21.1.4 When he makes the opponent fall down by falling down himself on purpose, only to get to his feet by means of a follow-through;

21.1.5 When the opponent is given a forcible counting; and

21.1.6 When the opponent receives a warning.

21.2 A competitor will be awarded one (1) point

21.2.1 When he hits the opponent's head or trunk with the fist technique;

21.2.2 When he hits the opponent's thigh with the leg technique;

21.2.3 When he falls down after the opponent:

21.2.4 When he makes the opponent fall down by falling down himself on purpose, without being able to get to his feet by means of a follow-through;

21.2.5 When the opponent fails to attack within eight (8) seconds after the order for appointed attack;

21.2.6 When the opponent fails to get to his feet within three (3) seconds after falling down on purpose;

21.2.7 When the opponent receives an admonition,

21.3 No point will be awarded to a competitor

21.3.1 When the techniques he uses are not clean and effective;

21.3.2 When both sides fall on or off the platform at the same time;

21.3.3 When the opponent falls on purpose as a fighting technique;

21.3.4 **When he hits the opponent in a clinch.**

## **Article 22 Fouls and Penalties**

### 22.1 Fouls

#### 22.1.1 **A competitor commits a technical foul**

- 1) **When he holds** the opponent **passively** or runs away **passively**;
- 2) **When he raises his hand to request to stop the bout in a disadvantageous situation**;
- 3) **When he delays** the fight **intentionally**;
- 4) **When he acts impolitely** towards the judges or disobeys **their decisions**;
- 5) **When he wears no gumshield or spits out his gumshield**, or loosens **his protective gear intentionally**; **and**
- 6) **When he fails to observe** the protocol.

#### 22.1.2 **A competitor commits a personal foul**

- 1) **When he attacks** the opponent before **the call of "Kaish (Start)!"** or after the **call of "Ting (Stop)!"**
- 2) **When he hits** the opponent on prohibited **areas**;
- 3) **When he hits** the opponent **with** any prohibited method.

### 22.2 Penalties

22.2.1 An admonition **will** be given for a technical foul.

22.2.2 A warning **will** be given for a personal foul.

22.2.3 A competitor **with three (3)** personal fouls **will** be disqualified from the bout.

22.2.4 A competitor who hurts **the** opponent intentionally **will** be disqualified from the whole competition, with **all his** results annulled.

22.2.5 A competitor who **uses** prohibited substances or inhaling oxygen during **the rest period** **will** be disqualified from the whole competition, **with all his results annulled**.

## **Article 23 Stopping the Contest**

The **contest shall be stopped**

- 23.1 **When** a competitor falls on or off the platform (except for a purposeful fall);
- 23.2 **When** a competitor is penalized;.
- 23.3 **When** a competitor is injured.
- 23.4 **When** the competitors hold each other in a clinch for more than two (2) seconds without launching effective attacks, or any attack at all, or run away passively;
- 23.5 **When** a competitor falls on purpose and remains down for more than three (3) seconds;
- 23.6 **When** a competitor raises his hand to request a stop of the fighting for objective reasons;
- 23.7 **When** the head judge corrects a misjudgment or omission.
- 23.8 **When** some problem or dangerous incident happens on the platform;
- 23.9 **When** competition is interrupted by some unforeseen troubles with the lighting or the competition area; and
- 23.10 **When** no attack is launched for eight (8) seconds after the order for appointed attack.

## CHAPTER 5

### WINNING AND PLACING

#### Article 24 **Determination of Wins and Losses**

24.1 Absolute victory

24.1.1 In a one-sided bout, the technically stronger will be declared the winner of the bout by the platform judge with the referee's approval.

24.1.2 During a bout, the competitor whose opponent has been knocked down and fails to get to his feet within ten (10) seconds after receiving heavy blows (except for personal fouls), or who has managed to get to his feet but remains in an abnormal state of consciousness, will be declared the winner of the bout.

24.1.3 During a bout , the competitor **whose** opponent has been forcibly counted three times after receiving heavy blows (except for personal fouls), will be declared the winner of the bout.

24.2 **Determination of the winner** of a round:

24.2.1 The result of each round **will** be decided by the side judges.

24.2.2 During a round, **the competitor whose opponent has been forcibly counted two (2) times after receiving heavy blows (except for personal fouls), will be declared the winner of the round.**

24.2.3 **During a round, the competitor whose opponent falls off the platform two (2) times, will be declared the winner of the bout.**

24.2.4 **In case of an equal number of points awarded in a round, the winner will be decided** in the following order:

- 1) **The competitor with fewer warnings will be declared** the winner.
- 2) **The competitor with fewer admonitions will be declared** the winner.
- 3) **The competitor with a lighter weight on the day of the contest will be declared** the winner.

24.2.5 If **the tie** remains, the **round goes as** a draw.

24.3 **Determination of the winner** of a bout

24.3.1 The competitor who wins two rounds **will** be the winner of the bout.

24.3.2 During the fighting, if a competitor is injured or ill and, as certified by the doctor, unable to continue the competition, **the opponent will be declared the winner of the bout.**

24.3.3 During **the** fighting, if a competitor feigns injury in a foul committed by the opponent – an injury as later proved by medical supervisors to be a mere **cheat**, the **fouling side will be declared the winner of the bout.**

24.3.4 **The competitor who is injured by the opponent in a foul and, as confirmed by medical supervisors, unable to continue the fight, will be declared the winner** of the bout, but he will be **barred from subsequent contests.**

24.3.5 **Under the round-robin system, an equal number of rounds won by the two sides in a bout will be declared a draw.**

24.3.6 **Under the elimination system, an equal number of rounds will be handled** as follows:

- 1 ) The competitor with fewer warnings will be declared the winner.
- 2 ) The competitor with fewer admonitions will be declared the winner.

If the tie remains, an additional round will be held.

## Article 25 Placing

25. 1 Placing of individuals:

25.1.1 Under the elimination system, the placing will be decided directly from the results.

25.1.2 Under the round-robin system, the competitor with a greater number of running points shall be placed higher. In case of a tie between two or more competitors, their places will be determined in the following order of precedence:

- 1) The competitor with fewer lost rounds will be placed higher.
- 2) The competitor with fewer warnings will be placed higher.
- 3) The competitor with fewer admonitions will be placed higher.
- 4) The competitor with a lighter weight at the time of drawing-lots will be placed higher.

If the tie remains, the competitors will share the tied place.

25.2 Placing of teams

25.2.1 Points for placing

- 1) The first eight places in each weight category will be awarded 9,7,6,5,4,3, 2 and 1 points respectively.
- 2) The first six places in each weight category will be awarded 7, 5, 4, 3, 2 and 1 points respectively.

25.2.2 If two or more teams are awarded equal points, the placing will be determined in the following order of precedence:

- 1) The team with more individual champions will be placed higher. If the tie remains, the team with more individual runners-up will be placed higher, and so on and so forth.
- 2) The team with fewer warnings will be placed higher.
- 3) The team with fewer admonitions will be placed higher.

If the tie remains, the teams will share the tied place.



## CHAPTER 6

### ARRANGEMENT OF COMPETITION AND RECORDING

#### Article 26 - Arrangement of Competition

26.1 Preparations for the arrangement

26.1.1 Study the Regulations for a full understanding of

- 1) The types and methods of competition
- 2) The schedule of the Competition
- 3) The classification of weight
- 4) The eligibility of participation and number of participants
- 5) The placing and prize-awarding methods

26.1.2 Examination of entry forms (Table 1)

26.1.3 Statistics of competitors in each weight category

26.2 General guidelines

26.2.1 All arrangements shall be made in accordance with the Regulations and on the basis of entry forms and general schedule of the Competition.

26.2.2 Contests of the same weight category and the same round should be comparatively concentrated and arranged on an equal basis.

26.2.3 At most two bouts (in different sessions) can be arranged for a competitor in one day.

26.2.4 Contests in the same session shall start with the lighter weight categories.

26.3 Arranging methods

26.3.1 Work out the rounds of competition and the number of bouts of each category according to the system of competition.

26.3.2 Compile a competition schedule (Table 2).

26.3.3 Work out the rounds of each category (Table 3).

26.3.4 Compile a Program for all bouts

26.3.5 Under the elimination system, the method of “drawing lots to decide the odd” may be adopted.

## **Article 27 Recording**

27.1 The sideline judges shall keep a record of the points awarded to each competitor according to the scoring criteria and the platform judge’s decisions. At the end of each round, they shall enter the competitors’ scores into the scorecard (Table 4).

27.2 The recorder shall keep a separate record of the admonitions, warnings, disqualification, passivity and forcible counting (Table 5).

27.3 Under the round-robin system, the programing-recording group shall enter the results of each bout into the scorecard, with two points for the winner, zero point for the loser and one point to both sides for a drawn bout. A winner by default shall be awarded two points and the defaulter zero point.

## Sanshou Competition Entry Form (Table 1)

Country/Region:

Team Leader:

Coach:

Doctor:

No.	Name	Sex	Birth y/m	Body- weight	48kg	52kg	56kg	60kg	65kg	70kg	75kg	80kg

Date: \_\_\_\_ (year) / \_\_\_\_ (month) / \_\_\_\_ (day)

Seal of Hospital:

Seal of Association:

Sanshou Competition Schedule (Table 2)

Time		Weight Category	Round No.	Bout No.		Notes
Date	Morning	kg Category	( )			
		kg Category	( )			
		kg Category	( )			
	Evening	kg Category	( )			
		kg Category	( )			
		kg Category	( )			
Date	Morning	kg Category	( )			
		kg Category	( )			
		kg Category	( )			
	Evening	kg Category	( )			
		kg Category	( )			
		kg Category	( )			
Date	Morning	kg Category	( )			
		kg Category	( )			
		kg Category	( )			
	Evening	kg Category	( )			
		kg Category	( )			
		kg Category	( )			

**Single Round Robin Competition (3 persons) (Table 3)**

1<sup>st</sup> Round

2<sup>nd</sup> Round

3<sup>rd</sup> Round

1—0

1—3

1—2

2—3

0—2

3—0

Number of persons=n, Number

$\frac{N(n-1)}{2}$

of Round = n- 1, Number of bout=

2

**Single round robin competition (3 persons)**

1st round    2nd round    3rd round

---

1---0	1---3	1---2
2---3	0---2	3---0

Number of persons = n,    number of rounds = n-1,

$$N(n - 1)$$

Number of bouts =  $\frac{N(n - 1)}{2}$

When n is an even number, the number of rounds = n- 1

When n is an odd number, the number of rounds = n

**Knockout competition (8 persons)**

Number of bouts = n - 1 (n is number of persons)

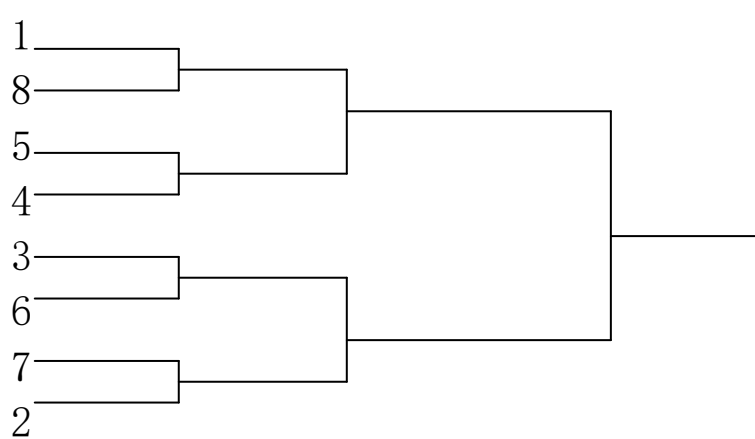

**Knockout competition with repechage (16 persons)**

Number of rounds =  $2n$  (n is two squared)

Number of bouts =  $2n - 2$  (n is the number of persons)

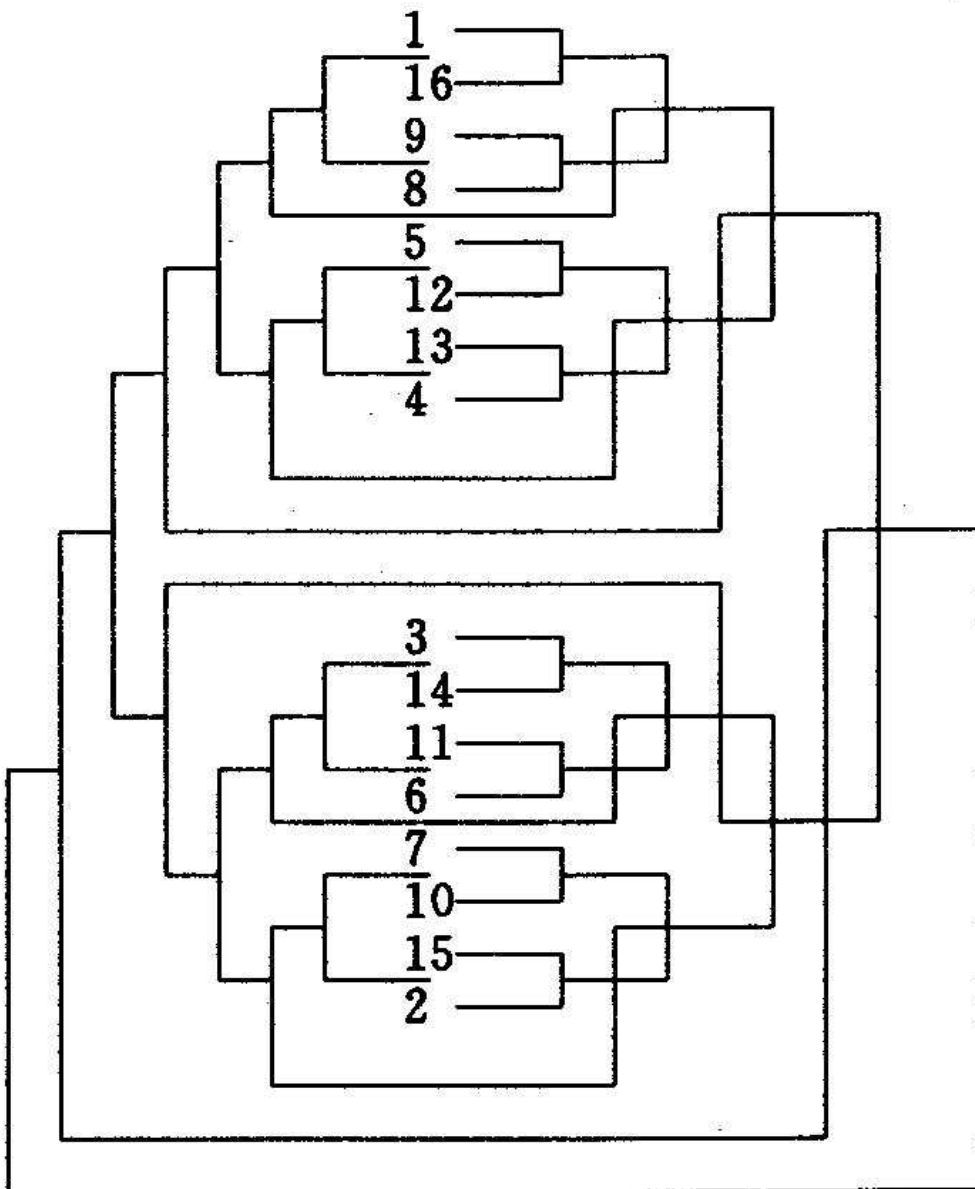

## Sideline Judges' Scorecard (Table 4)

Category \_\_\_\_\_

Judge Number \_\_\_\_\_

Color	Name	Country/ Region	1 <sup>st</sup> Round	2 <sup>nd</sup> Round	3 <sup>rd</sup> Round
Red					
Black					
Remarks					

Signature: \_\_\_\_\_

Date of contest: \_\_\_\_ (year) / \_\_\_\_ (month) \_\_\_\_ (day) Bout No. \_\_

## Recorder' s Chart (Table 5)

Category: \_\_\_\_\_ Red: \_\_\_\_\_ Weight: \_\_\_\_\_

Black: \_\_\_\_\_ Weight: \_\_\_\_\_

Penalty Name												
Round	警告	劝告	强制读秒	Off	Side-line Judge (1)	Side-line Judge (2)	Side-line Judge (3)	Side-line Judge (4)	Side-line Judge (5)	每局胜负	NO	Time
First												
Second												
Third												
Results												

Head Judge: \_\_\_\_\_

Recorder: \_\_\_\_\_

Date: \_\_\_\_ (Year) / \_\_\_\_ (month) / \_\_\_\_ (day)

Bout No. \_\_\_\_



# CHAPTER 7

## CALLS AND GESTURES

### Article 28 Platform Judge's Calls and Gestures

#### 28.1 Fist-Palm Salute

In a standing position with feet together, place the left palm against the right fist in front of and 20-30 cm away from the chest. (Figs 1 and 2).

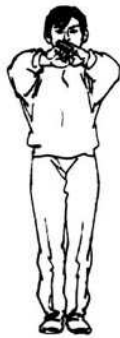

Fig 1



Fig 2

#### 28.2 Mount the platform

Standing at the center of the platform, extend both arms sideways, palms up and pointing at the competitors (Fig 3). As a call on them to mount the platform, bend both arms at the elbow into a right angle, palms facing each other (Fig 4).



Fig 3



Fig

4

#### 28.3 Competitors salute each other

Place the left hand on top of the right fist in front of the body as a signal to both competitors to salute each other (Fig 5).



Fig 5

#### 28.4 First round

Facing the head judge, **take a bow stance and, while** calling “Diyiju (First round) !” extend one arm forward with the index finger pointing up and the other three fingers and **the thumb clenched** into a fist (Fig 6).



Fig 6

#### 28.5 Second round

Facing the head judge, **take a bow stance and, while calling** “Di’erju (Second round) !”, extend one arm forward with the index and middle fingers separated **and** pointing up, and the thumb and the other two fingers **clenched** (Fig 7).



Fig 7

#### 28.6 Third round

Facing the head judge, **take a bow stance and, while calling** “Disanju (Third round) !”, extend one arm forward with the thumb and the index and middle fingers **separated and** pointing up and the other two fingers **clenched** (Fig 8).



Fig 8

Take a bow stance between the two competitors and, while calling “Yubei (Ready)!” extend both arms sideways, palm facing up and pointing at the competitors (Fig 9). Then, while calling “Kaishi (Start)!” cross pronated palms in front of the abdomen (Fig 10).



Fig 9



Fig 10

### 28.8 “Ting (Stop)!”

While calling “Ting (Stop)!” take a bow stance and insert one extended arm between the two competitors, fingers pointing up (Figs 11-12).



Fig 11



Fig

12

### 28.9 8-second passivity

While calling "Hongfang (Red side)!" or "Heifang (Black side)!" raise both hands in front of the body, with the small and ring fingers of one hand bent and the thumbs and other fingers of both hands separated and stretched naturally (Fig 13).



Fig 13

### 28. 10 Count

Facing the fallen competitor, with both arms bent at elbow and both hands clenched into fists in front of the body, palm side facing forward, unbend the fingers one by one from the thumb to the little finger, at an interval of one (1) second (Figs 14-15).



Fig 14



Fig

15

### 28.11 Passive hold

Fold the arms in front of the body (Fig 16).



Fig 16

28.12 8-second forcible counting

Facing the head judge, extend one arm with the thumb pointing up and the other fingers clenched (Fig 17)



Fig 17

28.13 Three seconds

While calling "Hongfang (Red side)!" or "Heifang (Black side)!" extend one arm obliquely up with the palm supinated and pointing at the competitor. Meanwhile, move the other hand across the abdomen to the side of the body, with the thumb and the index and middle fingers separated naturally and the other two fingers clenched (Fig 18).



Fig 18

28.14 Appointed attack

Extend one arm between the two competitors, with the thumb extended and the fingers clenched, palm side down. While calling "Hongfang (Red side)!" or "Heifang (Black side)!" move the hand horizontally in the direction of the thumb as a signal for appointed attack (Fig 19).



Fig 19

#### 28.15 Down

While calling "Hongfang (Red side)!" or "Heifang (Black side)!" extend one arm with palm facing up and pointing at the fallen competitor, as the other arm moves to the side of the body, bent at elbow and with palm facing down (Fig 20).



Fig 20

#### 28.16 Down First

Extend one arm towards the competitor who is the first to fall down and, while calling "Hongfang (Red side)!" or "Heifang (Black side)!" cross the arms in front of the abdomen, palms facing down (Figs 21-22).



Fig 21



Fig 22

### 28.17 Simultaneous fall

Extend both arms horizontally forward and withdraw them to press both palms down (Fig 23).



Fig 23

### 28.18 One side off the platform

Extend one arm towards the competitor off the platform (Fig 24) and, while calling "Hongfang (Red side)!" or Heifang (Black side)!" push the other hand forward in a bow stance, fingers pointing up (Fig 25).



Fig 24



Fig 25

### 28.19 Both sides off the platform

Take a bow step and push both palms forward, arms fully stretched and fingers pointing up (Fig26). Then bend both arms at elbow into a right angle in front of the body, palms facing back, while bringing the feet together to stand upright (Fig 27).



Fig 26



Fig

27

### 28.20 Kick the crotch

Extend one arm **towards** the offender and, **while calling** "Hongfang (Red side)!" or "Heifang (Black **side**)!" point the other hand at **the crotch, palm facing inward** (Fig 28).



Fig 28

### 28.21 Hit the back of head

Extend one arm **towards** the offender **and, while calling** "Hongfang (Red side)!" or "Heifang (Black **side**)!" **place** the other hand on the back of the head (Fig 29).



Fig 29

### 28.22 Elbow foul

**Bend both** arms in front of **the** chest and, **while calling** "Hongfang (Red side)!" or "Heifang (Black **side**)!" cover one elbow **with** the other **hand** (Fig 30).





Fig 30

#### 28.23 Knee foul

Raise one knee and, while calling "Hongfang (Red side)!" or "Heifang (Black side)!" pat the knee with the hand of the same side (Fig 31).



Fig 31

#### 28.24 Warning

Extend one arm towards the offender, palm up. While calling "Hongfang (Red side)!" or "Heifang (Black side)!" bend the other arm at elbow into a right angle, fingers clenched into a fist with the thumb side facing outward (Fig 32).



Fig 32

#### 28.25 Admonition

Extend one arm towards the offender, palm up. While calling "Hongfang (Red side)!" or "Heifang (Black side)!" indicate the foul with the other hand and bend the arm at elbow into a right angle in front of the body, fingers pointing up and palm facing backward (Fig 33).



Fig 33

### 28.26 Disqualification

While calling "Hongfang (Red side)!" or "Heifang (Black side)!" clench both hands into fists and cross the forearms in front of the body (Fig 34).



Fig 34

### 28.27 Not valid

Extend both arms and cross them in a swing in front of the abdomen (Figs 35-37).



Fig 35



Fig 36



Fig 37

### 28.28 Emergency treatment

Facing the medical supervision desk, cross forearms in front of the chest, fingers pointing up (Fig 38)



Fig 38

28.29 Rest

Extend both arms sideways, palms up, to point at the competitors' rest places (Fig 39).



Fig 39

28.30 Exchange positions

Standing at the center of the platform, cross arms in front of the abdomen (Fig 40)



Fig 40

28.31 Draw

Standing between the competitors, hold their wrists and raise their hands. (Fig 41).



Fig 41

### 28.32 Winner

Standing between the competitors, hold the winner's wrist and raise his hand (Fig 42).



Fig 42

## Article 29 Sideline Judges' Gestures

### 29.1 Off or down

Point down with a forefinger, with the other four fingers clenched (Fig 43).



Fig 43

### 29.2 Not off or down

Move one hand from side to side once, fingers pointing up (Fig 44).



Fig 44

29.3 Not seen clearly

**Bend both arms at elbow and spread forearms sideways** in front of **the** body, palms up (Fig 45).



Fig 45

## CHAPTER 8

### COMPETITION AREA AND EQUIPMENT

#### Article 30 Competition Area

30.1 The competition area **shall** be a platform of wooden structure, 80 cm high, 800 cm long and 800 cm wide, covered with a soft **mat** and a canvas surface. **At** the center of the platform is the Logo of International Wushu Federation, 120 cm in diameter. The **edges of the platform surface are marked with red sidelines 5 cm in width**. A yellow warning line, 10 cm **in width**, is drawn 90 cm inside the **sidelines**.

30.2 The platform is surrounded by protective **mats** 30 cm **thick** and 200 cm wide.

## Article 31 Equipment

### 31.1 Colored plates

A total of eighteen (18) plates -- six (6) in black, six (6) in red, and six (6) half in red and half in black -- are used by the sideline judges to indicate the winner, the loser and a drawn bout respectively. The plate is a disc 20 cm in diameter, with a wooden handle 20 cm in length (Fig 1).

# 擂台平面示意图

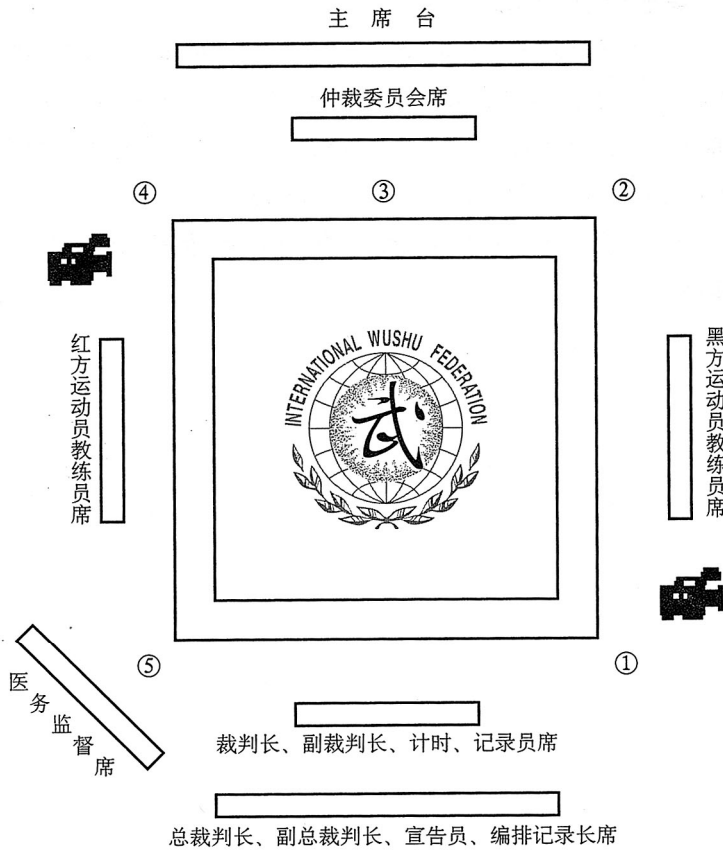

注：①②③④⑤为边裁判员席  
图标  为仲裁摄像席

## A Sketch of the Platform

Rostrum

Jury of Appeal

④

③

②

@

⑤

5

@

①

Referee, Assistant Chief Referee, Timekeeper, Recorder

Coach of the Red Side

Coach of the Black Side

Medical Supervision

Chief Referee, Assistant Chief Referee, Announcer,

Chief Programr-Recorder

Notes: The encircled figures ①②③④⑤ are seats for the sideline judges.  
The mark @ is a symbol for video-cameraman working for the Jury of Appeal.

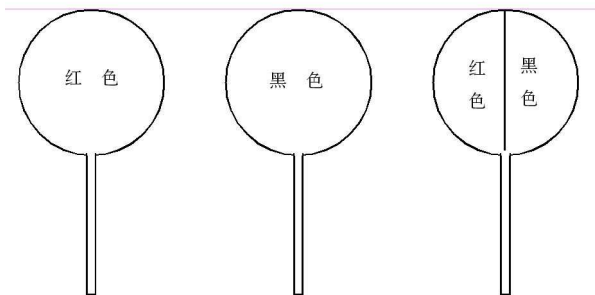

(图一)

Fig 1



### 31.2 Admonition cards

Twelve (12) 15cmX5cm yellow cards are used for admonition, with the Chinese characters “**劝告**” on them (Fig 2).

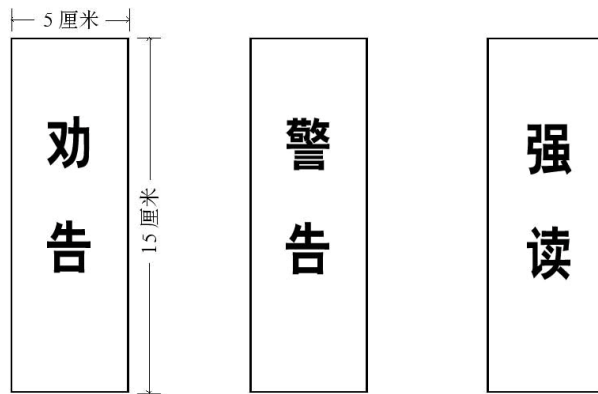

(图二)

(图三)

(图四)

Fig 2

Fig 3

Fig 4

### 31.3 Warning cards

Six (six) 15cmX5cm red cards are used for warning, with the Chinese characters “**警告**” on them (Fig 3).

### 31.4 Forcible counting cards

Six (6) 15cmX5cm blue cards are used for forcible counting, with the Chinese characters “**强读**” on them (Fig 4).

### 31.5 Card racks

Two (2) racks -- one in black and one in red -- are used for holding the cards. They are 60 cm long and 15 cm high (Fig 5).



(图五)

Fig 5

### 31.6 Default plates

Two (2) yellow plates are used for default, with the Chinese characters “弃权” on them — written in red color on one side and in black color on the other side. The plate is a disc 40 cm in diameter, with a wooden handle 40 cm in length (Fig 6).

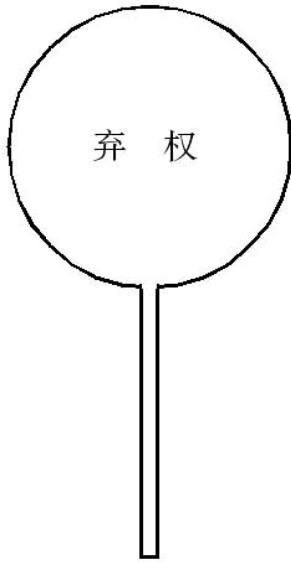

(图六)

Fig 6

- 31.7 Two (2) stop-watches (one as reserve)
- 31.8 Two (2) whistles (one with single pitch, the other with double pitches)
- 31.9 Three (3) megaphones
- 31.10 One (1) gong, with a rack and a hammer
- 31.11 Fifteen to twenty (15-20) tally counters
- 31.12 Two (2) video cameras
- 31.13 Two (2) metric scales
- 31.14 Three (3) wireless microphone (to be pinned on the platform judge's breast)
- 31.15 One (1) set of electronic scoring system